

rational[®]
WINDOWS & DOORS

OPERATION & MAINTENANCE



CONGRATULATIONS ON YOUR NEW RATIONEL® WINDOWS & DOORS

You have chosen a high quality product that has been produced in accordance with traditional high quality Danish construction principles and manufactured in Rationel's modern factories.

The information contained in this document is important to guarantee that your windows and doors will function for many years to come.

Professional installation of your windows and doors will ensure optimum functionality including ensuring they are clean and free from all builders dirt and spoil from the construction process. This will enable the installer to fully adjust all units and ensure they are ready for many years of use.

Finally it is important that you check this, and maintain the windows and doors correctly to ensure trouble-free operation over many years. These maintenance guidelines are described in this Operation & Maintenance Manual, as well as details on ventilation and how to create a healthy indoor climate.

Thank you for choosing Rationel as your supplier. We hope that you will enjoy the benefits of your new windows and doors.

Yours faithfully,
Rationel Windows (UK) Ltd.

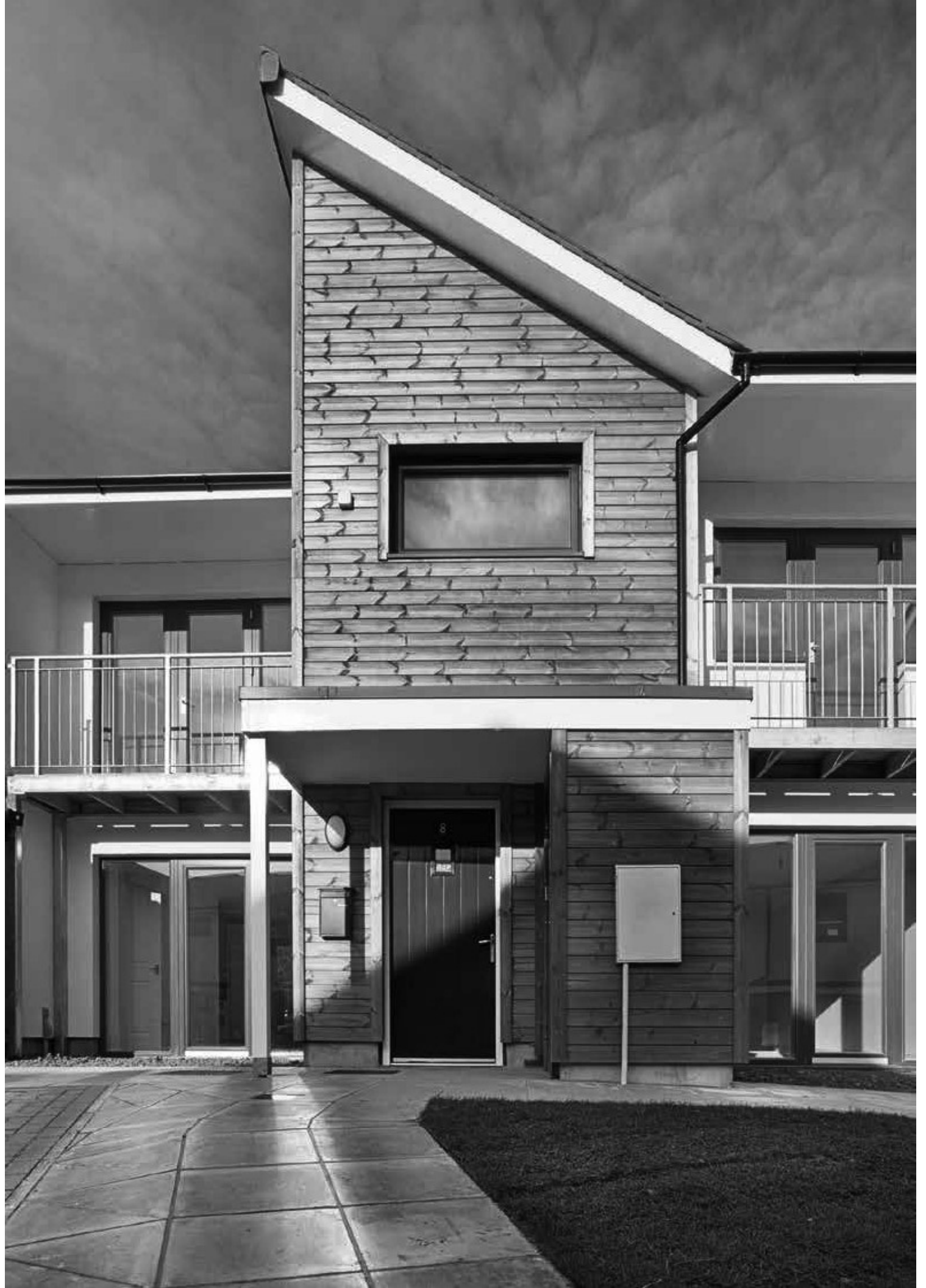

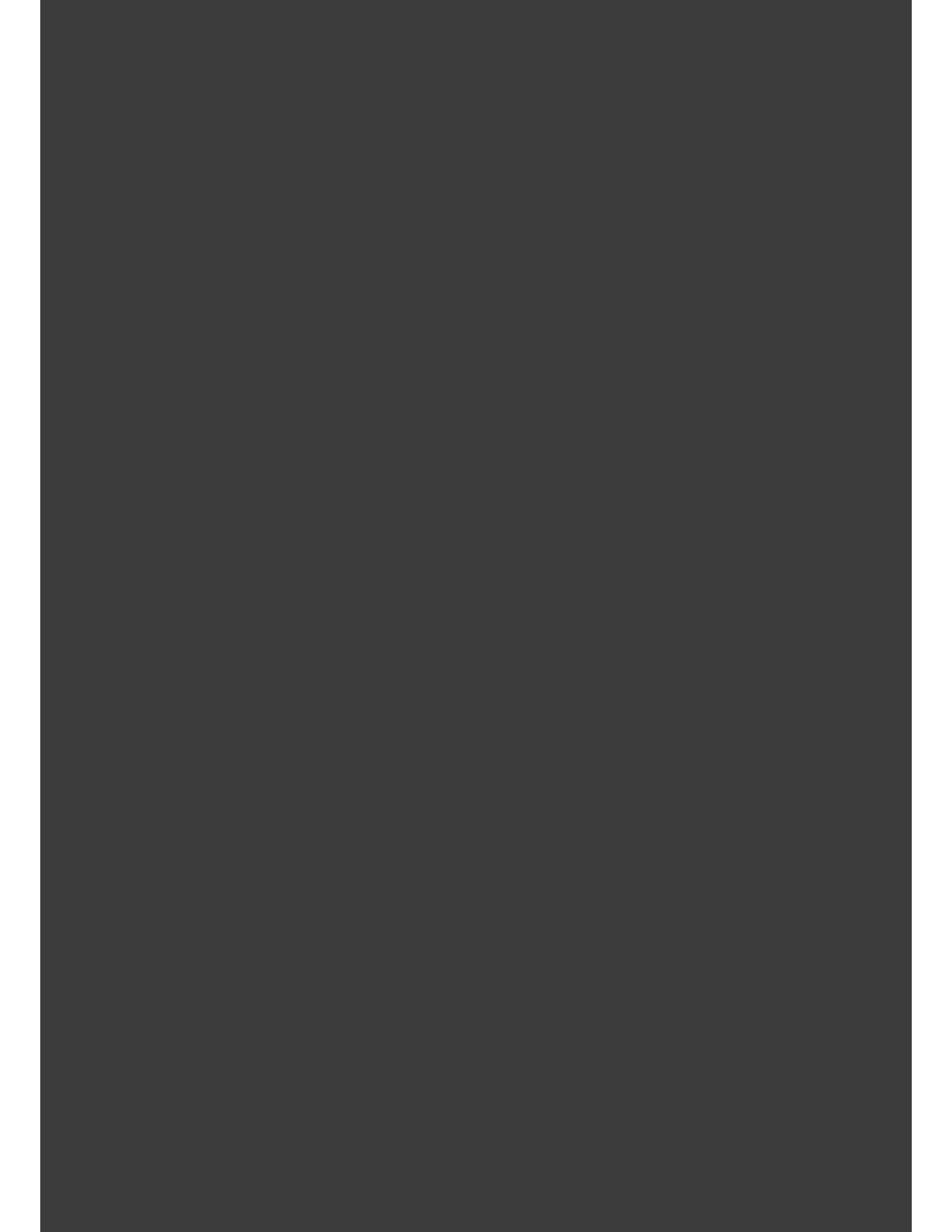

CONTENTS

GLOSSARY	6
YOUR WINDOW	7
CARE AND MAINTENANCE	8
VENTILATION AND INDOOR CLIMATE	10
Condensation on windows	10
Finger-jointed timber	11
Warranty	11
OPERATION AND ADJUSTMENT WINDOWS	
AURA & RATIONEL AURAPLUS	14
DOMUS & ALDUS	16
PATUS & PATUS+	18
OPERATION AND ADJUSTMENT DOORS	
AURA & RATIONEL AURAPLUS	20
DOMUS, ALDUS, PATUS & PATUS +	22

WINDOWS & DOORS GLOSSARY

The diagrams shown below will make it easier to understand the technical terms used in this manual.

WINDOWS

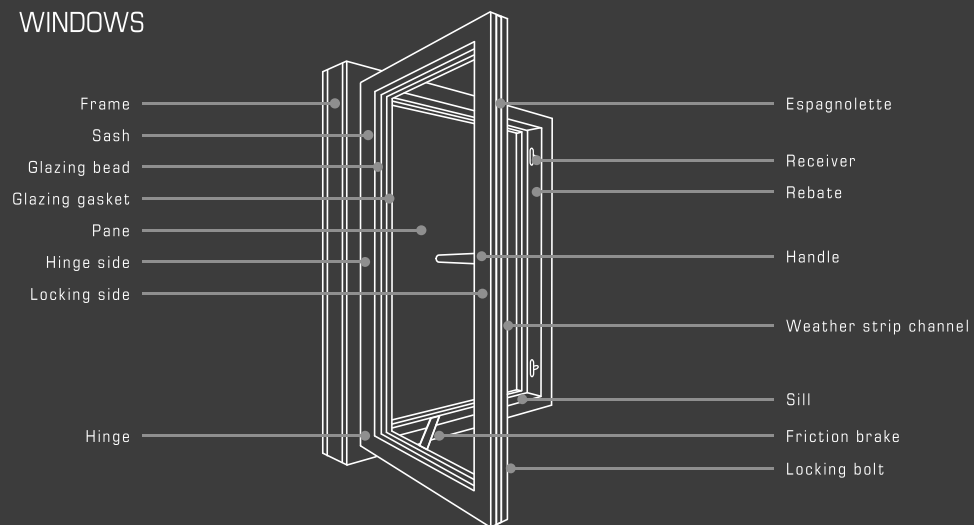

DOORS

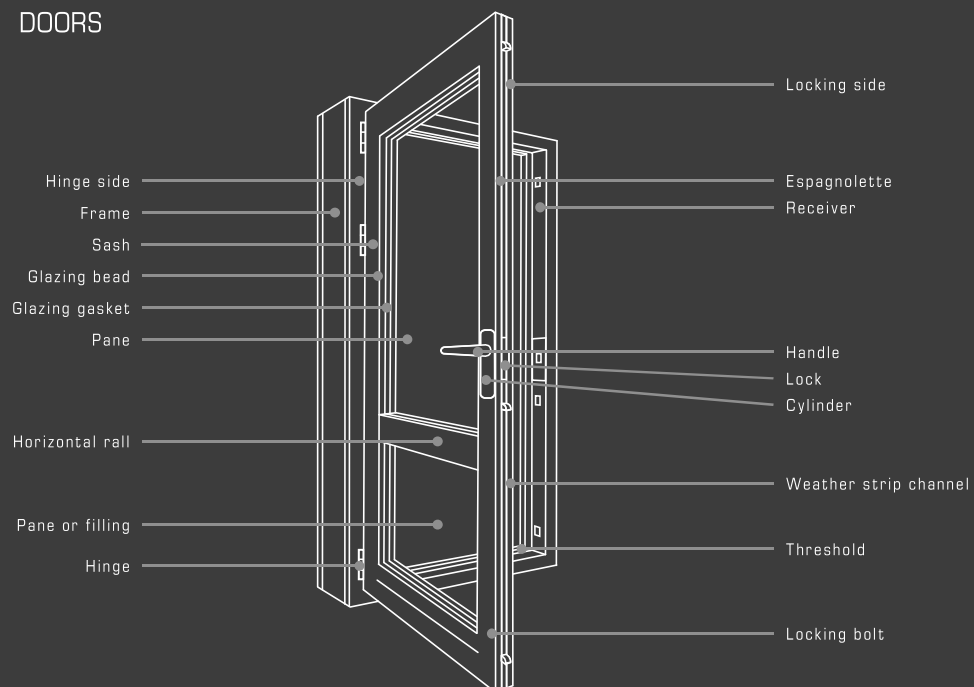

YOUR WINDOW

To ensure the appropriate maintenance is carried out it is important to correctly identify the product range. Below is a brief description of the six product ranges and a typical sectional picture.

RATIONEL AURA[®] RATIONEL AURAPLUS[®]

The design is elegant and the window has a slim construction. Timber is the core material in both product ranges. Rationel AURA is a timber window, while Rationel AURAPLUS has an external aluminium cladding.

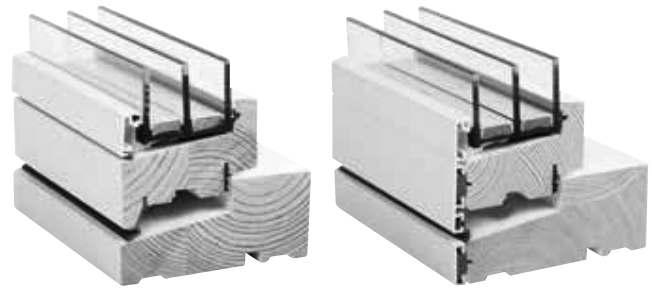

DOMUS[®] ALDUS[®]

The timber sash and frame have a timeless and modern design. DOMUS is timber inside and outside, and ALDUS has an additional external aluminium cladding.

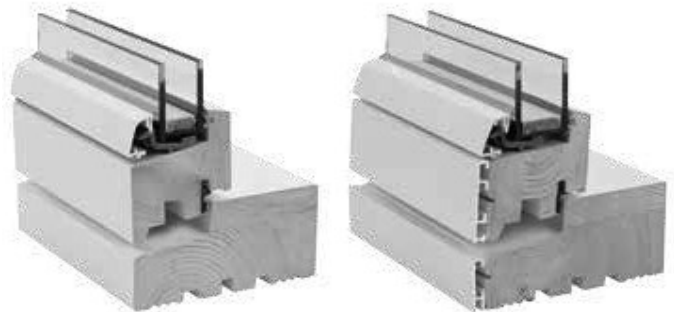

PATUS[®] PATUS+[®]

Both product ranges are made from the same timber window. The frame and sash have a bevelled edge internally; a feature characteristic of classical windows. PATUS is a classical timber window, inside and out, whilst PATUS+ has an additional external aluminium cladding.

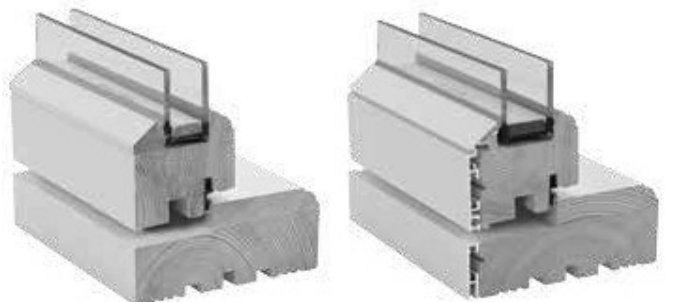

CARE & MAINTENANCE

Once you have clearly identified the type of product follow the general guidelines set out below for either timber or aluminium external finish and the internal timber finish.

EXTERNAL MAINTENANCE OF TIMBER

Rationel AURA, DOMUS and PATUS

We recommend that you wash the frames and sashes twice a year to remove dirt and other kinds of impurities. Use water, mixed with a mild household cleaning product.

A visual inspection should also be carried out once a year, to check the external surfaces are free from any splits or cracks in the paintwork or timber. UV rays from the sun can also effect the surface treatment - especially on south and west facing elevations.

Properties without overhanging eaves will also be more exposed to the UV rays. Any cracks in the paintwork or timber, will allow moisture to penetrate into the product and over time cause decomposition of the timber.

When carrying out remedial works to your windows and doors make sure that the humidity of the timber is between 15% to 18% and the ambient temperature between 10 to 20°C. To avoid the effect of dew also avoid early mornings and later in the day, to enable paintwork to dry.

EXTERNAL MAINTENANCE OF ALUMINIUM

RATIONEL AURAPLUS, ALDUS AND PATUS+

Windows with external aluminium cladding require minimal maintenance, and cleaning externally twice a year.

If the window has been subject to vandalism or any other kind of physical damage, small scratches can be repaired using a polish. In cases of deep scratches, oxidation will automatically close "the wound" and prevent corrosion. Damage like this can be difficult to repair without leaving a "scar", so the advice is to leave the scratch; it will not affect the life span of your window.

INTERNAL MAINTENANCE OF TIMBER

The internal part of the window is virtually maintenance free although it may be necessary to wash grease or smoke off the frame and sash from time to time. Clean the frame and sash with a cloth and mild soapy water.

MAINTENANCE OF RUBBER GASKETS

Rubber gaskets are maintenance free apart from ordinary cleaning, with a cloth and soapy water.

When carrying out remedial works be careful not to get paint on the rubber gaskets as they will lose their flexibility, and compromise the seal and tightness of the window when closed.

CLEANING THE GLASS

Glass labels on new windows can be removed by soaking them in water. Label residues on the glass can be removed by gently using a cleaner designed for ceramic hobs.

Although your windows may be cleaned at regular intervals, as a minimum the glass should be cleaned approx. 4 times per annum. When cleaning we recommend using a soft brush, a squeegee and some mild soapy water. Add some rinse aid to prevent chalky marks.

LUBRICATION OF HARDWARE

Window hardware will need occasional care. We recommend that you oil all mobile hardware parts twice a year with acid free oil to keep them moving smoothly. Use oil intended for sewing machines, WD-40 or similar. For Rational AURA/AURAPLUS, side guided windows, use Interflon Fin Lube RF.

Windows situated in exposed areas, particular coastal locations (within 5 miles), must be oiled more often. Under extreme conditions it will be necessary to check if hardware is still fully functional more regularly.

Furthermore, make sure that any gliding tracks on windows are kept clean and free of dirt.

VENTILATION & INDOOR CLIMATE

All new windows are airtight. This often means that you need to change your habits when getting new windows, as you might have had old and draughty ones previously. The old, draughty windows made sure that your home was naturally ventilated, even when you did not want it.

Now you have to make sure that your home is ventilated properly. It is a myth that it wastes energy and money to ventilate your home; you just have to do it correctly.

Leave a window or door wide open - it is ideal with a little draught. This way you replace the warm and moist air in the home with cold and dry air from the outside in less than 10 minutes. During this short period of time there will be no cooling of heavy items like furniture, floors and ceilings and the loss of energy will be at a minimum.

Proper ventilation is especially important in new buildings. Damp from new walls and floors can stay in the home for up to two years.

If you make sure that your home is thoroughly ventilated a couple of times every day - eg. bedrooms and bathrooms in the morning and kitchen, dining room and living room in the evening - you will ensure that you and your family have a pleasant and healthy indoor living climate.

CONDENSATION ON WINDOWS

Condensation on panes is often a sign of too little ventilation - but not always. It depends on whether the condensation is placed on the inside, the outside or between the two pieces of glass in the pane.

CONDENSATION ON THE OUTSIDE OF THE WINDOW – A GOOD THING

When condensation is placed on the outside of the window, it proves that it is an energy pane and that it is working the way it should.

In some certain types of weather - for example, on a clear and frosty night, where there is a large heat dissipation from the earth into the air - there can be times in the morning where the outside surface of the pane is colder than the air outside. This can result in external condensation in the middle of the pane. This type of condensation will disappear when the temperature outside rises during the day.

This type of condensation is caused by the energy pane. The inner piece of glass has a non-visible coating that reflects the heat back into the room. The space between the two pieces of glass is filled with argon an inert gas. This means that heat from the house cannot touch the outer piece of glass and heat it up. That is why it is possible for the outside of the energy pane to become colder than the air outside.

Condensation on the outside of the pane cannot arise on old traditional panes. On old types of panes there will always be some heat transferred through the glass to heat up the outer piece of glass.

CONDENSATION ON THE INSIDE OF THE WINDOW – VENTILATE!

If condensation is placed on the inside of the pane it is a sign that the relative humidity in the home is too high. The humidity should be brought down if you want to avoid rot, damage caused by a damp and unhealthy indoorclimate.

CONDENSATION BETWEEN THE TWO PIECES OF GLASS – THE SEALED UNIT IS PUNCTURED!

Condensation can also appear inside the pane between the two pieces of glass. This is a sign that the sealed unit is punctured and should be replaced.

FINGER-JOINTED TIMBER

Rational use finger-jointed timber to produce windows and doors. That means that all significant knots are removed from the timber to minimise resin extract. As timber is a natural living material there maybe further resin extract occuring after manufacture.

Resin extract can be removed in the following ways:

- Use a soft cloth wet with white spirit to remove the extract - wipe it off gently. Wash the area with clean water afterwards.
- Resin that have crystallized can be removed with a brush or scraped away gently.

If the painted surface has been damaged during this process sand the area and apply new paint with a soft brush.

WARRANTY

Rational Windows are affiliated to the Danish Window Verification, which means that all of Rational's products are DVV-certified. DVV continuously inspects the products and the production making sure that both as a minimum meet the demands defined in VinduesIndustrien's - The Association of Danish Window Manufacturers - technical regulations.

The warranty covers manufacturing or material defects on windows and doors delivered and used in the United Kingdom. The warranty is valid for 5 years from the date of production. The panes are covered by the Glass Industry's warranty for punctured panes (5 years) and visual defects (1 year).

Please state the order number for the defective window or door when contacting Rational. The order number is a 6 digit code that is printed in the spacer bar between the two pieces of glass in the pane.

The warranty is not valid if the defect is caused by careless operation or lack of maintenance.

If the warranty claim is a result of incorrect installation, the claim should be directed towards the installer.

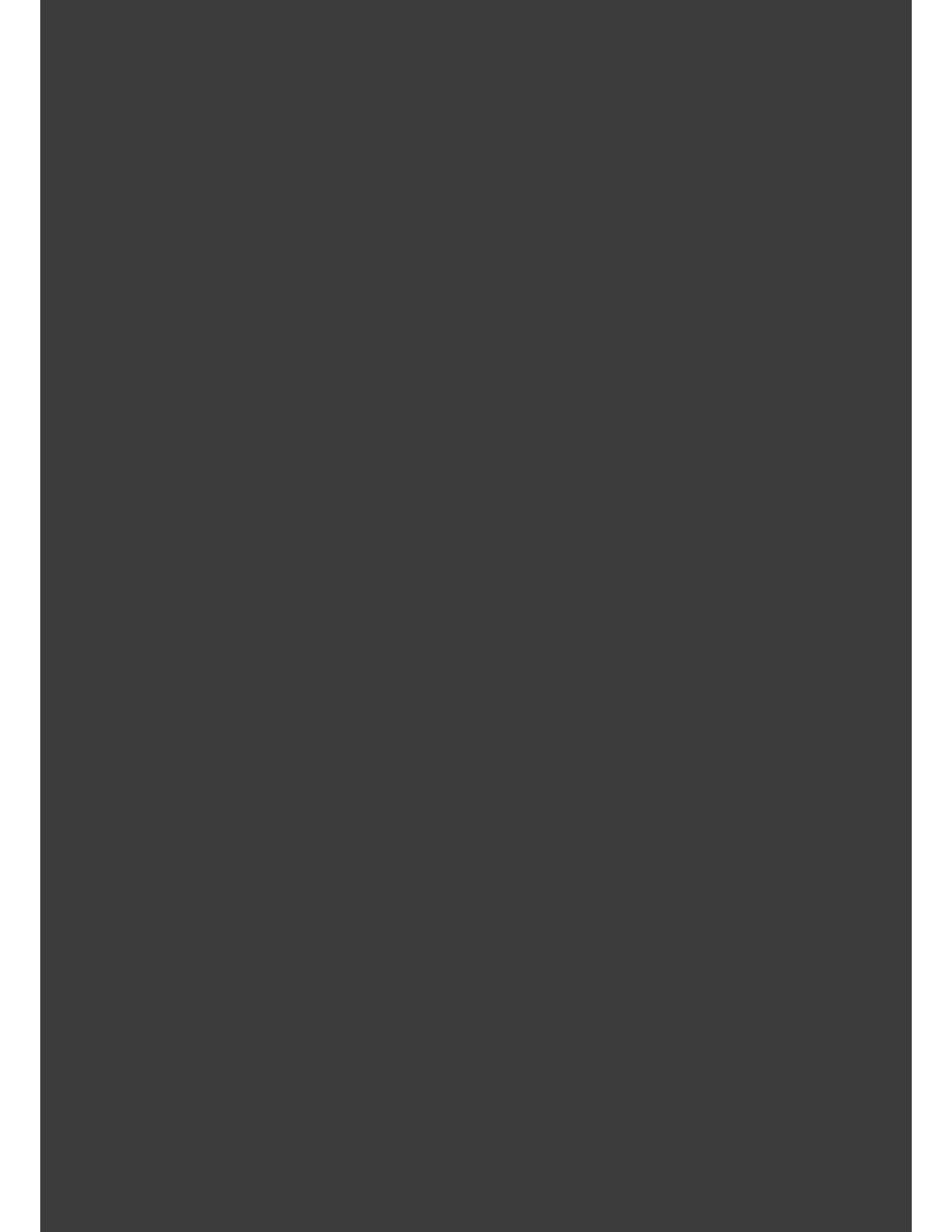

OPERATION & ADJUSTMENT

- Operation and adjustment of windows
- Operation and adjustment of doors

OPERATION & ADJUSTMENT OF WINDOWS

RATIONEL AURA and Rationel AURAPLUS

TOP GUIDED WINDOW

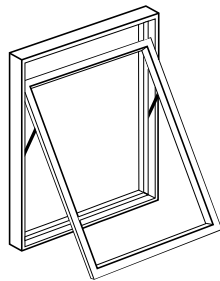

OPERATION

The window handle can be used to carry out the following three functions:

- 1) open the window
- 2) close the window
- 3) secure the window in the ventilation position

The top guided window has a built-in adjustable friction. The window can be kept open in any desired position. (Note: not suitable in strong winds.)

You can also use the ventilation position by turning the handle to horizontal position. The closing mechanism must catch the outer of the two holes in the receiver plate located in the sill. The window is secured but allows fresh air to enter the room.

Please note - not all insurance companies cover break-ins committed through windows in ventilation position. Please check with your insurer.

ADJUSTMENT

If required, the position of the sash within the frame can be adjusted by turning the adjustment screw placed in the hinge arm placed on the sash (illustration A). For this purpose use a 5mm Allen key.

Adjust the friction by loosening or fastening the screw with a 4mm Allen key (illustration B).

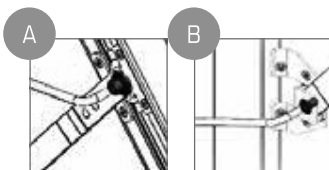

TOP SWING WINDOW

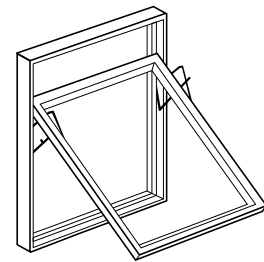

OPERATION

The window handle can be used to carry out the following three functions:

- 1) open the window
- 2) close the window
- 3) secure the window in the ventilation position
- 4) reverse the window for cleaning

The top swing window can swing open so that the outside can be cleaned from the inside. For safety reasons the window has a built-in restrictor that prevents the window from being fully opened. To release the restrictor, pull the window back by approx. 1 cm and use a finger to unhook the restrictor. The window should now push open.

When the window is fully reversed, a catch automatically engages to keep it in the cleaning position. Make sure that the window is locked in position before cleaning it.

To close the window again open the window even further bringing it towards you, and disengage the catch manually.

You can also use the ventilation position by turning the handle to horizontal position. The closing mechanism must catch the outer of the two holes in the receiver plate located in the jamb. The window is secured but allows fresh air to enter the room.

ADJUSTMENT

If required, the position of the sash within the frame can be adjusted by turning the adjustment rivet placed in the jamb in both sides (illustration B). For this purpose use a 22mm open-end spanner. Take off the plastic piece while making the adjustment to make room for the open-end spanner (illustration C).

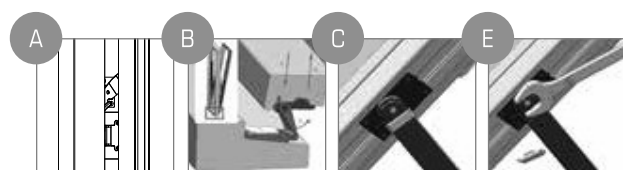

OPERATION & ADJUSTMENT OF WINDOWS

RATIONEL AURA and Rationel AURAPLUS

SIDE HUNG WINDOW

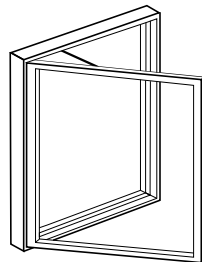

OPERATION

The window handle can be used to carry out the following three functions:

- 1) open the window
- 2) close the window
- 3) secure the window in the ventilation position

The handle in side hung windows is over 424mm wide and 530mm high are connected to a friction brake that can keep the window open. (Note: not suitable in strong winds.) The friction brake is activated by turning the handle to the vertical position when the window has reached the desired opening location.

Alternatively the window can be secured in the ventilation position by turning the handle to vertical position when the closing mechanism catch is located above the outer of the two holes in the receiver plate located in the jamb.

Please note - not all insurance companies cover break-ins committed through windows in ventilation position. Please check with your insurer.

Double casement windows can be fitted with a false mullion to comply with local fire regulations. The handle on the secondary leaf has a built-in child safety device.

ADJUSTMENT

If required, the height of the sash within the frame can be adjusted by turning the adjustment screws in the jambs (illustration A). Use a 5mm Allen key for this purpose. Sideways adjustment is also done by using a 5mm Allen key (illustration B).

It is important that the screws are turned evenly to avoid distortion.

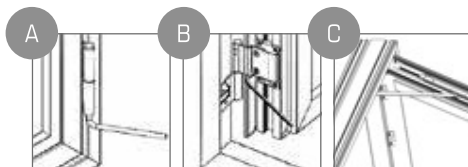

SIDE GUIDED WINDOW / SIDE SWING WINDOW

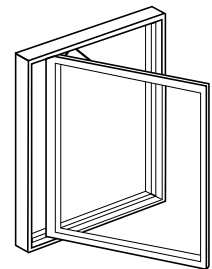

OPERATION

The window handle can be used to carry out the following three functions:

- 1) open the window
- 2) close the window
- 3) secure the window in the ventilation position

SIDE-GUIDED WINDOW / SIDE-SWING WINDOW

The side-guided window can open in the hinge side making it possible to clean the outside of the window.

The side-swing window can swing open so that the outside can be cleaned from the inside. The opening angle depends on the sash width. When opening the sash, an opening restrictor releases (illustration A) which must be deactivated to swing the sash to the cleaning position. The opening restrictor (illustration A) also works as a cleaning catch when the sash has been fully opened.

You can also use the ventilation position by turning the handle to vertical position. The closing mechanism must catch the outer of the two holes in the receiver plate located in the jamb. The window is secured but allows fresh air into the room.

Please note - not all insurance companies cover break-ins committed through windows in ventilation position. Please check with your insurer.

ADJUSTMENT

To adjust the sash height loosen the set screw placed horizontally at the lower hinge using a 2.5mm Allen key (illustration A). Adjust the sash either up or down by turning the set screw placed vertically at the bottom of the lower hinge using a 4mm Allen key (illustration B) and finish by fastening the first screw again. For sideways adjustment turn the adjustment screw placed at the top and at the bottom of the frame (illustration C).

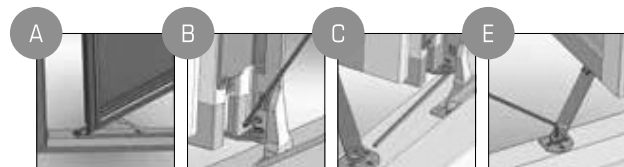

OPERATION & ADJUSTMENT OF WINDOWS

Domus and aldus

TOP GUIDED WINDOW

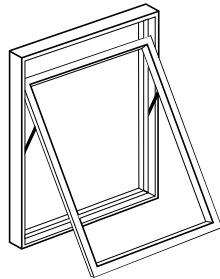

OPERATION

The window handle can be used to carry out the following three functions:

- 1) open the window
- 2) close the window
- 3) secure the window in the ventilation position

The top guided window has a built-in adjustable friction brake. The brake keeps the window open in any desired position - however it is not suitable in strong winds.

You can also use the ventilation position by turning the handle to horizontal position. The closing mechanism must catch the outer of the two holes in the receiver plate located in the sill. The window is secured but allows fresh air to enter the room.

Please note - not all insurance companies cover break-ins committed through windows in ventilation position. Please check with your insurer.

ADJUSTMENT

If required, the position of the sash within the frame can be adjusted by turning the adjusting screw placed in the jambs (illustration A). For this purpose use a 10mm open-end spanner.

Adjust the friction by turning the adjusting screw on the arm connecting the sash and frame on both sides of the window (illustration B). Use a 4mm Allen key. It is important that both screws are tightened evenly, otherwise the sash might become distorted over time.

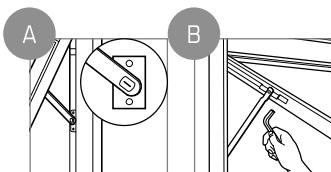

TOP SWING WINDOW

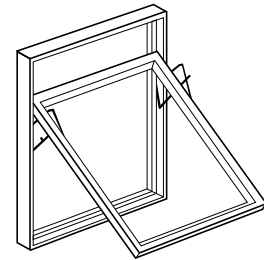

OPERATION

The window handle can be used to carry out the following three functions:

- 1) open the window
- 2) close the window
- 3) secure the window in the ventilation position
- 4) reverse the window for cleaning

The top swing window can swing open so that the outside can be cleaned from the inside. The window has a built-in child safety restrictor which stops the sash when it has been opened approx. 10 cm. To open the window further, lift the catch located on the right-hand side of the window (seen from the inside). The catch automatically re-engages when the sash has been fully opened for cleaning.

When the window is fully reversed, a catch automatically engages to keep it in the cleaning position. Make sure that the window has been fully reversed so that the catch is engaged before cleaning the window.

You can also use the ventilation position by turning the handle to horizontal position. The closing mechanism must catch the outer of the two holes in the receiver plate located in the sill. The window is secured but allows fresh air to enter the room.

ADJUSTMENT

If required, the position of the sash within the frame can be adjusted by turning the adjusting screw placed in the jambs (illustration A). For this purpose use a 17mm open-end spanner.

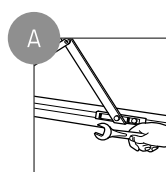

OPERATION & ADJUSTMENT OF WINDOWS

Domus and aldus

SIDE HUNG WINDOW

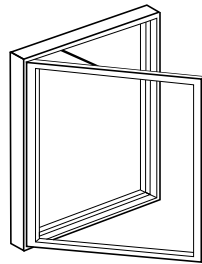

OPERATION

The window handle can be used to carry out the following three functions:

- 1) open the window
- 2) close the window
- 3) secure the window in the ventilation position

The handle on side hung windows over 478mm wide and 588mm high are fitted with a built-in adjustable friction brake. The brake keeps the window open in any desired position - however it is not suitable in strong winds. The friction brake is activated by turning the handle to a vertical position when the window has reached the desired opening location.

You can also use the ventilation position by turning the handle to vertical position. The closing mechanism must catch the outer of the two holes in the receiver plate located in the jamb. The window is secured but allows fresh air to enter the room.

Please note - not all insurance companies cover break-ins committed through windows in ventilation position. Please check with your insurer.

Double casement windows can be fitted with a false mullion to comply with local fire regulations. The mullion is an integrated part of the secondary sash and it follows the sash when opening the window. To open the secondary leaf disengage the handle placed on the mullion (illustration A).

ADJUSTMENT

If required, the position of the sash within the frame can be adjusted by turning the two adjustment screws - one placed in the sill and one in the head (illustration B). For this purpose use a 10mm open-end spanner.

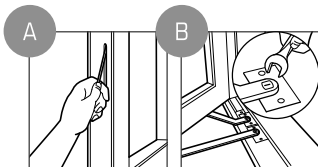

SIDE GUIDED WINDOW

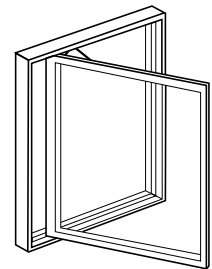

OPERATION

The window handle can be used to carry out the following three functions:

- 1) open the window
- 2) close the window
- 3) secure the window in the ventilation position

The window can be opened approx. 90° at which point an opening appears in the hinged side through which the outside of the window can be cleaned. The handle on windows over 743mm wide and 588mm high are fitted with a built-in adjustable friction brake. The height must also be minimum 588mm to achieve the brake. The brake keeps the window open in any desired position up to 90° - however it is not suitable for use in strong winds. The friction brake is activated by turning the handle to a closed position when the window has reached the desired opening location.

You can also use the ventilation position by turning the handle to vertical position. The closing mechanism must catch the outer of the two holes in the receiver plate located in the jamb. The window is secured but allows fresh air to enter the room.

Please note - not all insurance companies cover break-ins committed through windows in ventilation position. Please check with your insurer.

Double casement windows can be fitted with a false mullion to comply with local fire regulations. The mullion is an integrated part of the secondary sash and it follows the sash when opening the window. To open the secondary leaf disengage the handle placed on the mullion (illustration A).

ADJUSTMENT

If required, the position of the sash within the frame can be adjusted by turning the two adjustment screws - one placed in the sill and one in the head (illustration B). For this purpose use a 10mm open-end spanner.

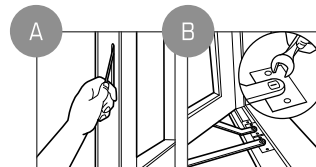

OPERATION & ADJUSTMENT OF WINDOWS

Domus, aldus, Patus and Patus+

TILT AND TURN WINDOW

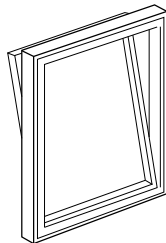

OPERATION

The window handle can be used to carry out the following three different functions.

1) Side hung position: when the handle is turned to a horizontal position the sash opens inwards making it possible to clean the outside of the window from the inside. It is not recommended to open the window fully in strong winds as the sash may become damaged.

2) Tilt position: when the handle is turned to a vertical upwards position, the sash can be opened approx. 10cm inwards at the top, allowing for excellent ventilation.

3) Closed position: the window is closed when the handle is in the vertical downwards position.

For a problem-free operation of the tilt and turn window, press lightly on the sash when changing from one position to another.

ADJUSTMENT

The closing pressure is adjusted by turning the back screw in the horizontal hinge at the bottom corner (illustration A) by using a 4mm Allen key, or by adjusting the locking rollers in the jamb (illustration B) by using a Torx screw 15.

If you have questions concerning the adjustments, please contact your installer.

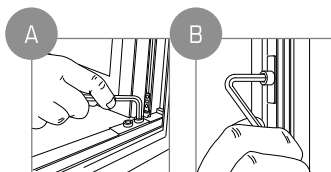

SIDE HUNG WINDOW

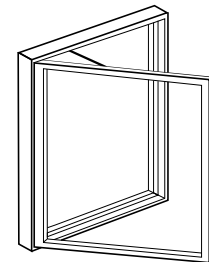

OPERATION

The window handle can be used to carry out the following three functions:

- 1) open the window
- 2) close the window
- 3) secure the window in the ventilation position

The handle on side hung windows over 458mm wide and 582mm high a built-in adjustable friction brake. The brake keeps the window open in any desired angle - however it is not suitable for strong winds. The friction brake is activated by turning the handle to a vertical position when the window has reached the desired opening location.

You can also use the ventilation position by turning the handle to vertical position. The closing mechanism must catch the outer of the two holes in the receiver plate located in the jamb. The window is secured but allows fresh air to enter the room.

Please note - not all insurance companies cover break-ins committed through windows in ventilation position. Please check with your insurer.

Double casement windows can be fitted with a false mullion to comply with local fire regulations. The mullion is an integrated part of the secondary sash, which follows the sash when opening the window. To open the secondary leaf disengage the handle placed on the mullion (illustration A).

ADJUSTMENT

If required, the position of the sash within the frame can be adjusted by turning the screw on the bottom hinge in the sash. For this purpose use a 5mm Allen key (illustration B).

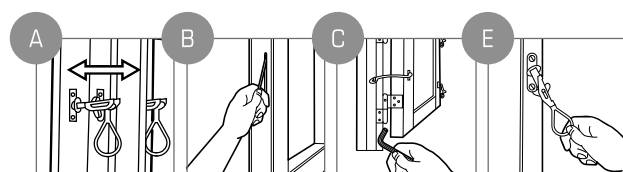

OPERATION & ADJUSTMENT OF WINDOWS

Patus and Patus+

SIDE GUIDED WINDOW

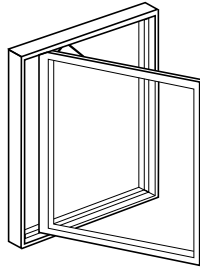

OPERATION

The window handle can be used to carry out the following three functions:

- 1) open the window
- 2) close the window
- 3) secure the window in the ventilation position

The window can be opened approx. 90°, at which point an opening appears in the hinged side through which the outside of the window can be cleaned.

You can also use the ventilation position by turning the handle to vertical position. The closing mechanism must catch the outer of the two holes in the receiver plate located in the jamb. The window is secured but allows fresh air to enter the room.

Please note - not all insurance companies cover break-ins committed through windows in ventilation position. Please check with your insurer.

Double casement windows can be fitted with a false mullion to comply with local fire regulations. The mullion is an integrated part of the secondary sash and it follows the sash when opening the window. To open the secondary leaf disengage the handle placed on the mullion (illustration A).

ADJUSTMENT

If required, the position of the sash within the frame can be adjusted by turning the two adjustment screws - one placed in the sill and one in the head (illustration B). For this purpose use a 10mm open-end spanner.

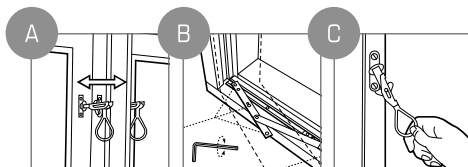

TOP GUIDED WINDOW

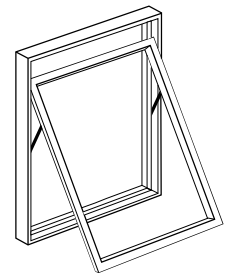

OPERATION

The window handle can be used to carry out the following three functions:

- 1) open the window
- 2) close the window
- 3) secure the window in the ventilation position

The top guided window has a built-in adjustable friction brake. The brake keeps the window open in any desired position - however it is not suitable for use in strong winds.

You can also use the ventilation position by turning the handle to horizontal position. The closing mechanism must catch the outer of the two holes in the receiver plate located in the sill. The window is secured but allows fresh air to enter the room.

Please note - not all insurance companies cover break-ins committed through windows in ventilation position. Please check with your insurer.

ADJUSTMENT

If required, the position of the sash within the frame can be adjusted by turning the adjusting screw placed in the jambs (illustration A). For this purpose use a 10mm open-end spanner.

Adjust the friction by turning the adjusting screw on the arm connecting the sash and frame on both sides of the window (illustration B). Use a 4mm Allen key. It is important that both screws are tightened evenly, otherwise the sash may become distorted over time.

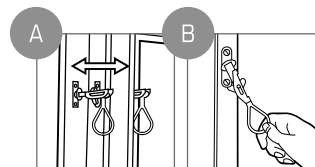

OPERATION & ADJUSTMENT OF DOORS

RATIONEL AURA and Rationel AURAPLUS

ENTRANCE DOOR



OPERATION

The handle on a Rationel entrance doors can activate one or three locking points. When locking the door, the top and bottom locking points need to be activated. Lift the handle upwards and when you feel resistance, all three locking points are activated. Let go of the handle, turn the key and the door is locked correctly. To ensure a fully functional door all three locking points must be activated each time the door is closed.

ADJUSTMENT

Adjustment of a Rationel door can be carried out without dismantling the door leaf. The height between door and sill can be regulated $\pm 2.5\text{mm}$ by adjusting the thread pivot in the bottom of all the hinges (illustration A). Use a 6mm Allen key. If sideways adjustment is necessary, loosen the four screws that fasten the hinge to the frame by using a Torx screw 20 (illustration B) and adjust the two small hexagonal screws on the jamb (illustration C) using a 3mm Allen key. Finally tighten the 4 screws in the frame again.

To regulate the pressure against the gasket adjust the position of the striking plate. Remove the two locators on the top plate with pincers, which makes it possible to move the outer striking plate in the receiver either forwards or backwards (illustration D).

The built-in sash lifter that supports the door when it is closed, must be adjusted after fitting the door. Loosen the screw in the hardware using a Torx 25 and a small wheel will be released at the bottom of the sash. The wheel can be adjusted up- or downwards by loosening or tightening the screw (illustration E).

When adjustment is completed the wheel must rest on the threshold when the door is in a closed position.

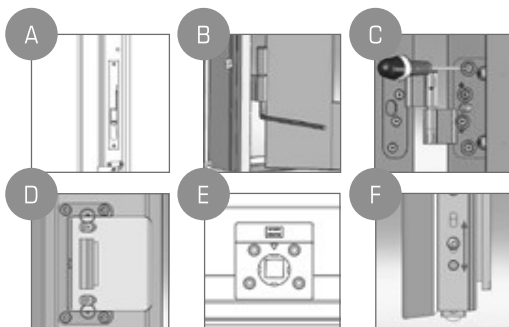

TERRACE DOOR



OPERATION

The terrace door is operated with a handle that activates a locking mechanism with three locking points. The handle is connected to a friction brake, making it possible to keep the terrace door open in any desired position - however it is not suitable for use in strong winds. To activate the friction brake turn the handle downwards when the door has reached the desired opening angle.

ADJUSTMENT

Adjustment of a Rationel door can be carried out without dismantling the door leaf. The height between door and sill can be regulated $\pm 2.5\text{mm}$ by adjusting the thread pivot in the bottom of all the hinges (illustration A). Use a 6mm Allen key. If sideways adjustment is necessary, loosen the 4 screws that fasten the hinge to the frame by using a Torx screw 20 (illustration B) and adjust the two small hexagonal screws on the jamb (illustration C) using a 3mm Allen key. Finally tighten the 4 screws in the frame again.

To regulate the pressure against the gasket adjust the position of the striking plate. Remove the two locators on the top plate with pincers, which makes it possible to move the outer striking plate in the receiver either forwards or backwards (illustration D).

The built-in sash lifter that supports the door when it is closed, must be adjusted after fitting the door. Loosen the screw in the hardware using a Torx 25 and a small wheel will be released at the bottom of the sash. The wheel can be adjusted up- or downwards by loosening or tightening the screw (illustration E).

When adjustment is completed the wheel must rest on the threshold when the door is in a closed position.

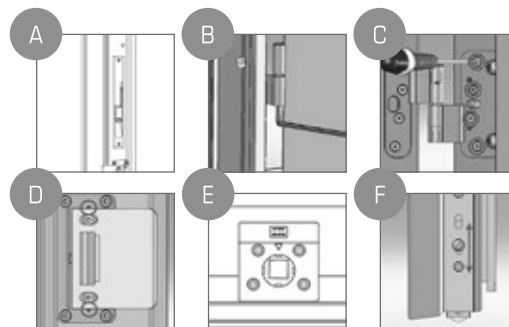

OPERATION & ADJUSTMENT OF DOORS

RATIONEL AURA and Rationel AURAPLUS

WINDOW DOOR

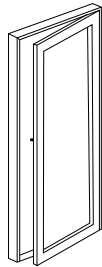

OPERATION

The window door is operated by a handle that activates a locking mechanism with three locking points. The handle is connected to a friction brake, making it possible to keep the window door open in any desired location - however it is not suitable for use in strong winds. To activate the friction brake turn the handle downwards when the door has reached the desired opening angle. The window door is also available as a double door. The secondary leaf is opened by de-activating the child safety device.

ADJUSTMENT

If required, the height of the sash within the frame can be adjusted by turning the adjustment screws. Use a 5mm Allen key for this purpose (illustration A). Sideways adjustment is also done by using 5mm Allen key (illustration B). It is important that the screws are adjusted evenly to avoid distortion. It is also possible to adjust the sash within the frame with ± 1 mm when adjusting the sash lifter. For this purpose use a 4mm Allen key (illustration C).

SLIDING PATIO DOOR

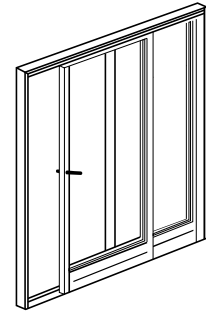

OPERATION

The sliding patio door is opened by turning the handle 180° downwards. Two sets of wheels are pressed downwards, lifting the moveable part of the door allowing it to slide sideways. Close the door by reversing the process.

ADJUSTMENT

If the moveable door is closing too tightly or too loosely, you can adjust the bolts placed in the jamb on the closing side (illustration A).

The distance between the moveable and the fixed sash is adjusted on the door stile connector in the moveable sash (illustration B).

Keep the rail and the wheels clear of grime and dirt to get a fully functional sliding patio door.

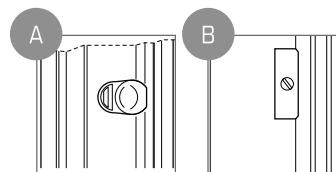

OPERATION & ADJUSTMENT OF DOORS

Domus, aldus, Patus and Patus+



ENTRANCE DOOR

OPERATION

The handle on a Rational entrance doors can activate one or three locking points. When locking the door, the top and bottom locking points need to be activated. Lift the handle upwards and when you feel resistance, all three locking points are activated. Let go of the handle, turn the key and the door is locked correctly. To ensure a fully functional door all three locking points must be activated each time the door is closed.

ADJUSTMENT

Adjustment of a Rational door can be carried out without dismantling the door leaf. The height between door and sill can be regulated up to 5mm by adjusting the thread pivot in the bottom of the centre hinge (illustration A). Use a 6mm Allen key. If sideways adjustment is necessary, loosen the 4 screws that fasten the hinge to the frame (use a Torx screw 20) and adjust the two small hexagonal screws on the jamb using a 3mm Allen key. Finally tighten the 4 screws in the frame again.

To regulate the pressure against the gasket adjust the position of the striking plate. Remove the two locators on the top plate with pincers, which makes it possible to move the outer striking plate in the receiver either forwards or backwards (illustration B).

The built-in sash lifter that supports the door when it is closed, must be adjusted after fitting the door. Loosen the two screws in the hardware and a small wheel will be released at the bottom of the sash. The wheel can be adjusted up- or downwards by loosening or tightening the two screws. When adjustment is completed the wheel must rest on the threshold when the door is in a closed position.

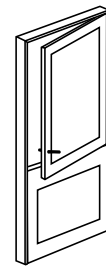
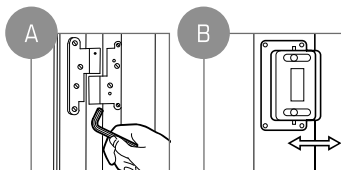

STABLE DOOR

OPERATION

A Rational stable door has two handles that are used for operating three functions:

1)

It can be operated as an ordinary entrance door: turn the bottom handle to a horizontal position and operate the door with the top handle.

2)

To create ventilation by leaving the top half of the door open: turn the bottom handle downwards to vertical position. Open the top half of the door using the top handle.

3)

To lock the door: turn the bottom handle downwards to vertical position. Lift the handle upwards. When you feel resistance all locking points are activated. Let go of the handle, turn the key and the door is locked correctly with four locking points - two in each half of the door.

ADJUSTMENT

Adjustment of a Rational door can be carried out without dismantling the door leaf. The height between door and sill can be regulated up to 5mm by adjusting the thread pivot in the bottom of the centre hinge (illustration A). Use a 6mm Allen key. If sideways adjustment is necessary, loosen the 4 screws that fasten the hinge to the frame (use a Torx screw 20) and adjust the two small hexagonal screws on the jamb. Use a 3mm Allen key. Finally tighten the screws again.

To regulate the pressure against the gasket adjust the position of the striking plate. Remove the two locators on the top plate with pincers, which makes it possible to move the outer striking plate in the receiver either forwards or backwards (illustration B).

The built-in sash lifter that supports the door when it is closed, must be adjusted after fitting the door. Loosen the two screws in the hardware and a small wheel will be released at the bottom of the sash. The wheel can be adjusted up- or downwards by loosening or tightening the two screws. When adjustment is completed the wheel must rest on the threshold when the door is in a closed position.

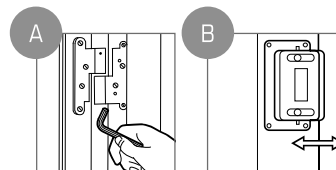

OPERATION & ADJUSTMENT OF DOORS

Domus, aldus, Patus and Patus+



TERRACE DOOR

OPERATION

The terrace door is operated with a handle that activates a locking mechanism with three locking points. The handle is connected to a friction brake, making it possible to keep the terrace door open in any desired position - however it is not suitable for use in strong winds. To activate the friction brake turn the handle downwards when the door has reached the desired opening angle. The terrace door is also available as a double door. The secondary leaf is opened by releasing the grip placed in the rebate on the jamb (illustration A).

ADJUSTMENT

Adjustment of a Rational door can be carried out without dismantling the door leaf. The height between door and sill can be regulated up to 5mm by adjusting the thread pivot in the bottom of the centre hinge (illustration B). Use a 6mm Allen key. If sideways adjustment is necessary, loosen the 4 screws that fasten the hinge to the frame (use a Torx screw 20) and adjust the two small hexagonal screws on the jamb. Use a 3mm Allen key. Finally tighten the screws again.

To regulate the pressure against the gasket adjust the position of the striking plate. Remove the two locators on the top plate with pincers, which makes it possible to move the outer striking plate in the receiver either forwards or backwards (illustration C). In the case of double terrace doors, the pressure against the gasket is adjusted by loosening the receivers placed on the head and sill (illustration D). Turn the top plates 90° clockwise or counter clockwise depending on whether the pressure needs to be increased or decreased. Finish by fastening the receivers again.

The built-in sash lifter that supports the door when it is closed, must be adjusted after fitting the door. Loosen the two screws in the hardware and a small wheel will be released at the bottom of the sash. The wheel can be adjusted up- or downwards by loosening or tightening the two screws. When adjustment is completed the wheel must rest on the threshold when the door is in a closed position.

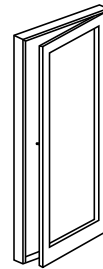
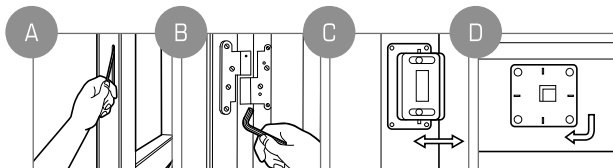

TILT AND TURN DOOR

OPERATION

The door is operated with the handle to give three functions.

1)

Side hung position: when the handle is turned to a horizontal position the sash is opened inwards making it possible to clean the outside of the door from the inside. In strong winds close the door, or make sure that the sash cannot open to an extent where it becomes undesirable or the sash could be damaged.

2)

Tilt position: when the handle is turned to a vertical upwards position, the sash can be opened about 10cm inwards at the top allowing ventilation.

3)

Closed position: the door is closed when the handle is in a vertical downwards position.

For efficient operation of the tilt and turn door, press lightly on the sash when changing from one position to another.

ADJUSTMENT

The closing pressure is adjusted by turning the back screw in the horizontal hinge at the bottom corner (illustration A) by using a 4mm Allen key, or by adjusting the locking rollers in the jamb (illustration B) by using a Torx screw 15.

If you have questions concerning the adjustments, please contact your installer.

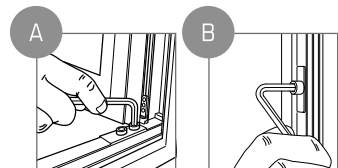

Rational first manufactured windows and doors in Sdr. Felding in 1954, and ever since the products have characterised quality and excellent workmanship. Based on this solid foundation, Rational has developed into an international company with sales activities in Denmark, Great Britain and Ireland.

As the market has developed, regulations and expectations changed, Rational has continuously sought to improve and expand its product range including efficient and energy saving products that exceed the statutory requirements of the future, whilst not compromising security, comfort or functionality.

For further information about our wide range of windows and doors, please visit www.rational.co.uk.

Rational is part of the DOVISTA Group which consists of ten leading door and window companies in Europe.